

**PHILIPS**

hue personal  
wireless  
lighting

Milliskin



HUE serial number

User manual  
Benutzerhandbuch  
Notice d'emploi  
Manual de usuario  
Manual do usuário  
Manuale d'uso

Incl.

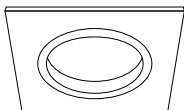
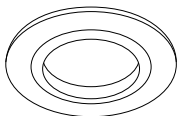

Excl.

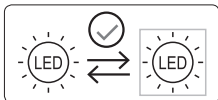
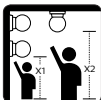
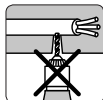
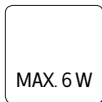
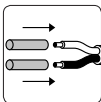
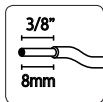
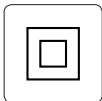
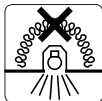
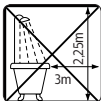
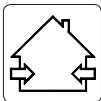
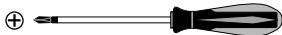
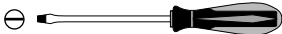
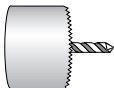
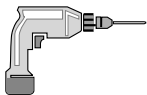

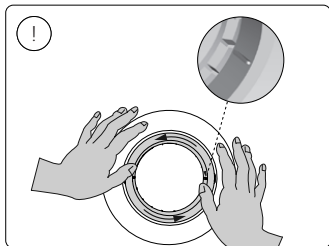
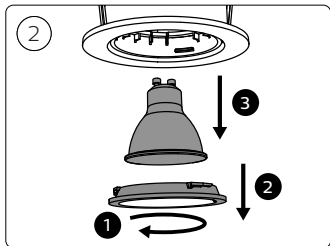
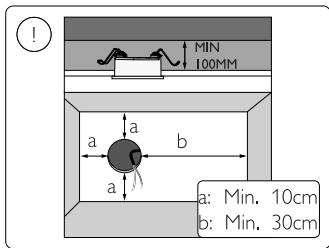
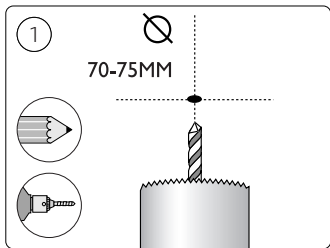
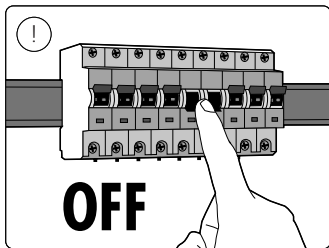
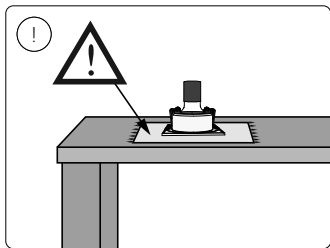

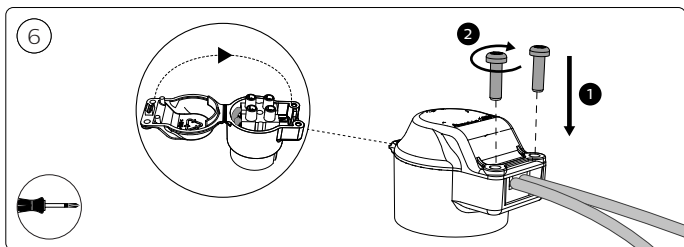
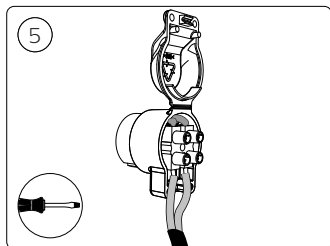
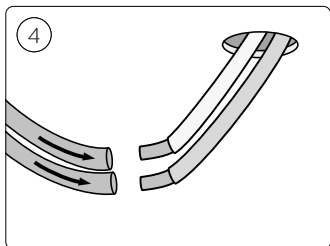
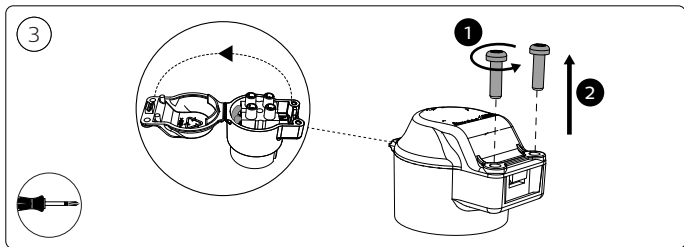

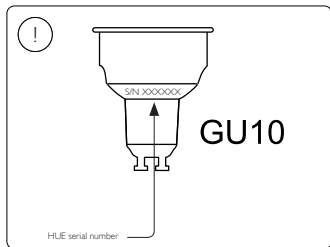
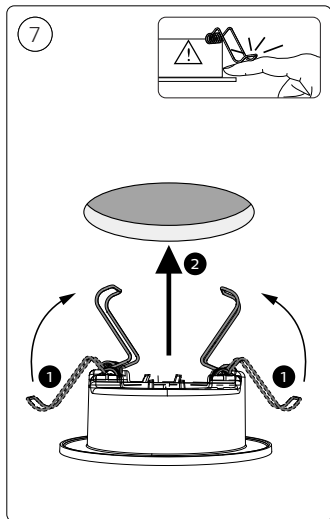

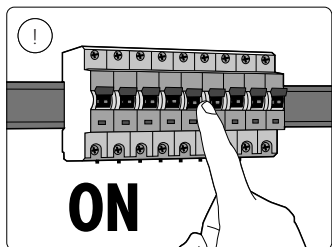
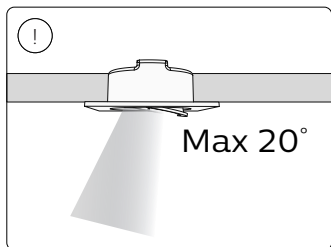
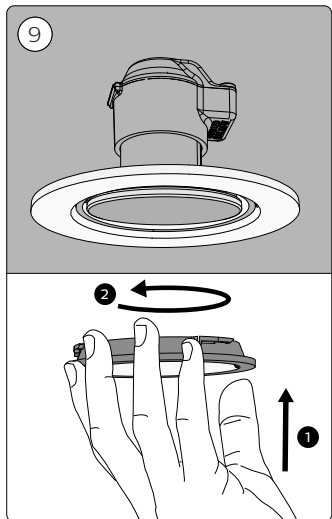
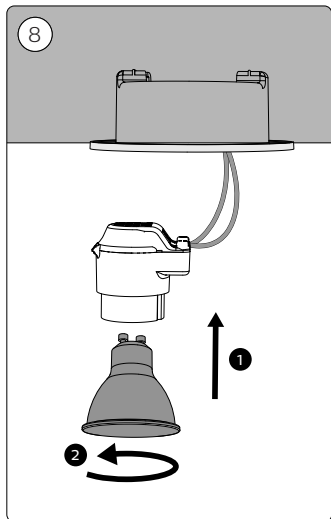

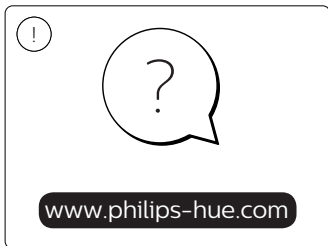
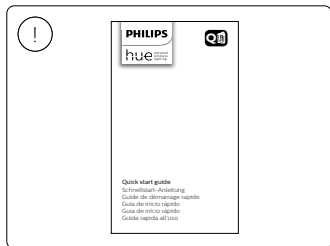



Signify  
I.B.R.S. / C.C.R.I. Numéro 10461  
5600 VB Eindhoven,  
the Netherlands  
☎00800-74454775

© 2021 Signify Holding  
All rights reserved

[www.philips-hue.com](http://www.philips-hue.com)

4404 029 06214  
Last update: 03/2021